

CANDIDATE  
NAME

CENTRE  
NUMBER

--	--	--	--	--

CANDIDATE  
NUMBER

--	--	--	--



**CO-ORDINATED SCIENCES**

**0654/63**

Paper 6 Alternative to Practical

**October/November 2019**

**1 hour 30 minutes**

Candidates answer on the Question Paper.

No Additional Materials are required.

**READ THESE INSTRUCTIONS FIRST**

Write your centre number, candidate number and name on all the work you hand in.

Write in dark blue or black pen.

You may use an HB pencil for any diagrams or graphs.

Do not use staples, paper clips, glue or correction fluid.

**DO NOT WRITE IN ANY BARCODES.**

Answer **all** questions.

Electronic calculators may be used.

You may lose marks if you do not show your working or if you do not use appropriate units.

At the end of the examination, fasten all your work securely together.

The number of marks is given in brackets [ ] at the end of each question or part question.

This document consists of **15** printed pages and **1** blank page.

1 A student investigates an enzyme-catalysed reaction.

Hydrogen peroxide is broken down by catalase, an enzyme found in living cells such as yeast cells. Oxygen gas is released during the reaction and a foam is produced above the liquid.

**(a) Procedure**

- The student places  $3\text{ cm}^3$  of yeast suspension into a measuring cylinder.
- He adds  $1\text{ cm}^3$  hydrogen peroxide solution to the yeast suspension in the measuring cylinder and starts a stopclock.
- He reads and records in Table 1.1 the total volume of the liquid and the foam that is produced every 30 seconds for 150 seconds.
- He repeats the procedure using  $2\text{ cm}^3$  hydrogen peroxide solution instead of  $1\text{ cm}^3$  hydrogen peroxide solution.

Fig. 1.1 shows the measuring cylinders at time  $t = 150$  seconds.

Read and record in Table 1.1 these volumes.

[2]

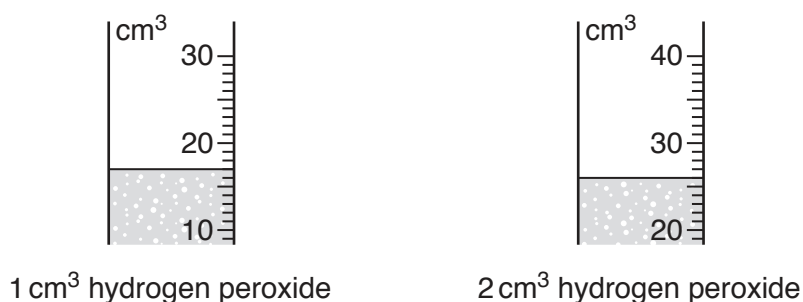

**Fig. 1.1**

**Table 1.1**

time /s	total volume of liquid and foam /cm <sup>3</sup>	
	1 cm <sup>3</sup> hydrogen peroxide	2 cm <sup>3</sup> hydrogen peroxide
0	4	5
30	10	13
60	13	18
90	15	22
120	16	25
150		

(b) On the grid provided, plot graphs of the total volume of liquid and foam against time for **both**  $1 \text{ cm}^3$  **and**  $2 \text{ cm}^3$  hydrogen peroxide.

- Choose a suitable scale.
- Plot a graph of total volume of liquid and foam against time for  **$2 \text{ cm}^3$**  hydrogen peroxide.
- Draw the best fit line and label this line  **$2 \text{ cm}^3$** .
- On the same axes, plot a graph of total volume of liquid and foam against time for  **$1 \text{ cm}^3$**  hydrogen peroxide.
- Draw the best fit line and label this line  **$1 \text{ cm}^3$** .

total  
volume  
of liquid  
and  
foam  
/ $\text{cm}^3$

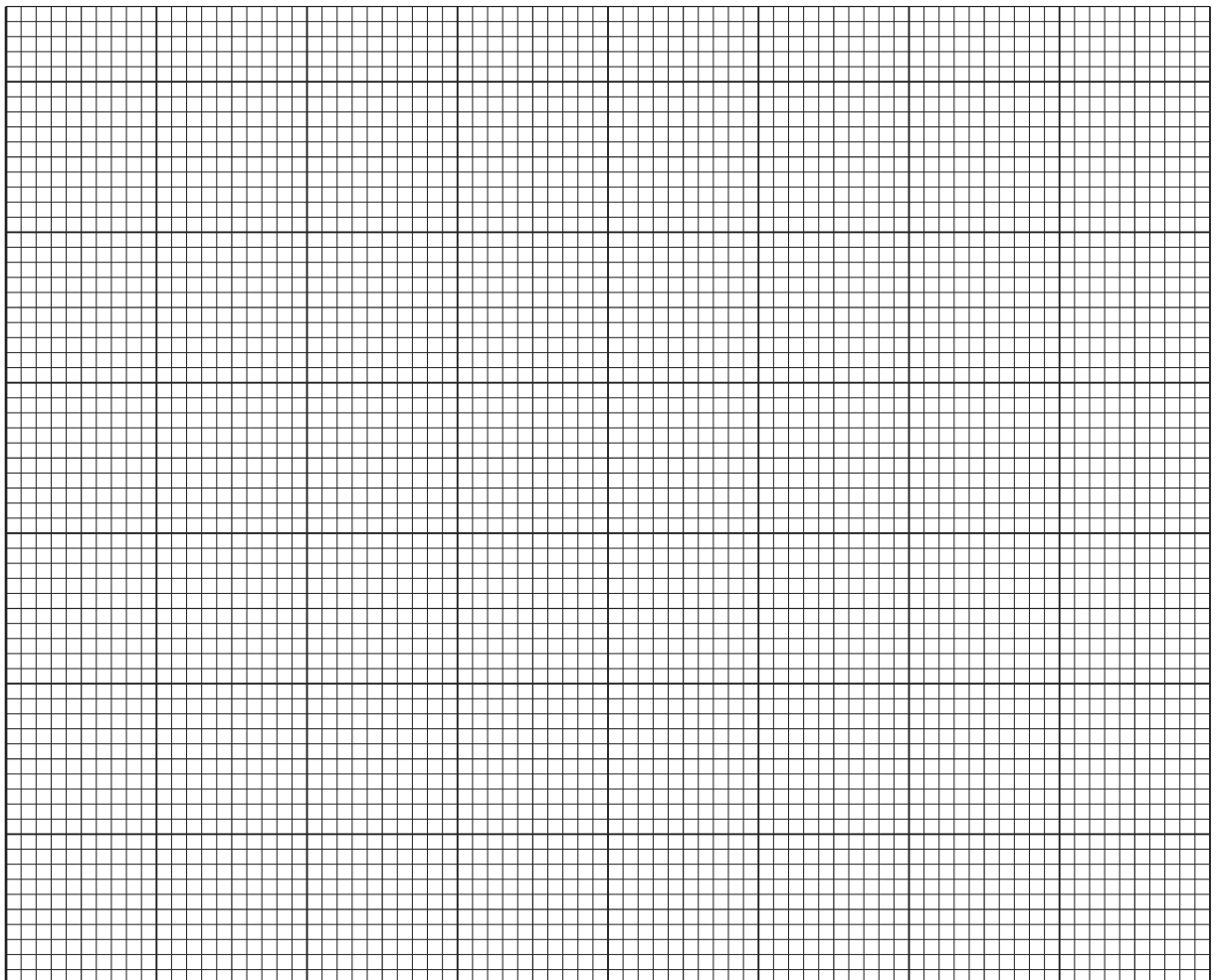

time /s

[5]

(c) State the effect of increasing the volume of hydrogen peroxide used on the rate of this reaction during the first 90 seconds.

..... [1]

(d) State and explain a safety precaution the student takes when carrying out the investigation.

..... [1]

- (e) Before he started the procedure in (a) the student recorded what the starting volumes were going to be for time = 0.

Explain how he worked out these values.

..... [1]

- (f) The student identified two sources of inaccuracy in this investigation.

- 1 Parallax (line of sight) error when reading the measuring cylinder.
- 2 The accuracy of the measuring cylinder.

- (i) Describe how parallax error can be avoided.

.....  
..... [1]

- (ii) State a piece of apparatus used for accurately measuring the volume of a gas released in a reaction.

..... [1]

[Total: 12]



2 A student investigates the nutrient content of yeast.

- (a)
- He adds some yeast suspension to two test-tubes.
  - To one test-tube, he adds an equal volume of biuret solution and stirs well.
  - To the other test-tube, he adds a few drops of iodine solution.

He obtains a **positive** result with the biuret solution and a **negative** result with the iodine solution.

Complete Table 2.1 by recording the final colour observed in each test-tube after adding the testing solutions.

State the conclusions from these results.

**Table 2.1**

test solution	final colour observed	conclusion
biuret solution		
iodine solution		

[4]

(b) The teacher says that the yeast produces carbon dioxide during respiration.

To test for carbon dioxide the gas produced is bubbled through limewater.

(i) Draw the assembled apparatus that should be used for this test.

[1]

(ii) Label the apparatus and chemicals in your diagram in (b)(i).

[1]

(iii) State the observation that confirms carbon dioxide is produced.

..... [1]

(c) Before adding the yeast, the liquid used to make the yeast suspension in (a) is tested with biuret solution and iodine solution.

Suggest why this is done.

..... [1]

[Total: 8]





(b) Identify **one** possible source of error in your experiment.

Explain an improvement to reduce the effect of this error.

source of error .....

.....

improvement.....

.....

[2]

[Total: 9]

4 **J** contains two cations and one anion.

A solution of **J** is pale green in colour and solid **J** is also green.

A student carries out some tests to identify the ions in **J**.

(a) She carries out the tests shown in Table 4.1 on separate solutions of **J** to identify the **anion**.

She records her observations and conclusions in Table 4.1.

Complete Table 4.1 by filling in the missing test reagents and observation.

**Table 4.1**

test reagent	observations	conclusion
	no reaction	not a carbonate
	no reaction	not a chloride
		sulfate

[4]

(b) She identifies the two **cations** in **J** by carrying out tests on separate solutions of **J** with sodium hydroxide solution.

Complete Table 4.2 by stating the conclusions that can be made from these tests and observations.

**Table 4.2**

test	observations	conclusion
add sodium hydroxide solution to <b>J</b>	green ppt.	
add sodium hydroxide solution to <b>J</b> then heat the mixture	green ppt. and damp red litmus held at mouth of test-tube turned blue	

[2]

(c) The student heats a sample of green solid J in a hard glass test-tube for several minutes.

She observes a colourless liquid condensing on the side of the test-tube and the solid turns brown.

She removes a small amount of the colourless liquid for testing in (c)(ii).

(i) Suggest why the student uses a hard glass test-tube instead of a normal test-tube.

.....  
..... [1]

(ii) The colourless liquid turns anhydrous copper(II) sulfate powder from white to blue.

Identify the colourless liquid.

..... [1]

(iii) The brown solid does not dissolve in water.

Suggest what the student can use to dissolve the brown solid.

.....  
..... [1]

(iv) The student makes a solution of the brown solid. The solution is orange.

She adds ammonia solution to the orange solution and observes a brown precipitate.

Identify the ion in the brown solid.

..... [1]

(v) The teacher tells the student that the brown solid can also be made by placing a suitable metal half in water and bubbling oxygen into the water.

Identify the metal and the process that takes place in the teacher's method.

metal .....

process.....

[1]

[Total: 11]

5 A student determines the volume of a drinks cup using two methods.

(a) (i) **Method 1**

- She places the cup with its open end facing down on a sheet of paper.
- She draws around the circumference of the open end of the cup with a pencil.

Fig. 5.1 shows the circle that she draws.

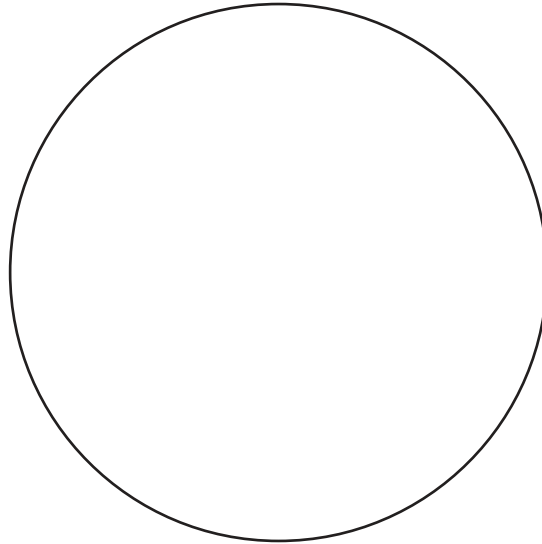

**Fig. 5.1**

Measure and record to the nearest 0.1 cm the diameter  $D$  of the circle.

$D = \dots\dots\dots$  cm [1]

- (ii)
- She turns the cup over and places it with its closed end facing down on the sheet of paper.
  - She draws around the circumference of the closed end of the cup with a pencil.

Fig. 5.2 shows the circle that she draws.

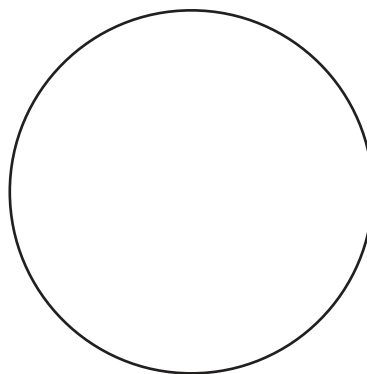

**Fig. 5.2**

Measure and record to the nearest 0.1 cm the diameter  $d$  of the circle.

$d = \dots\dots\dots$  cm [1]

(b) Measure and record to the nearest 0.1 cm the height  $h$  of the cup shown on Fig. 5.3.

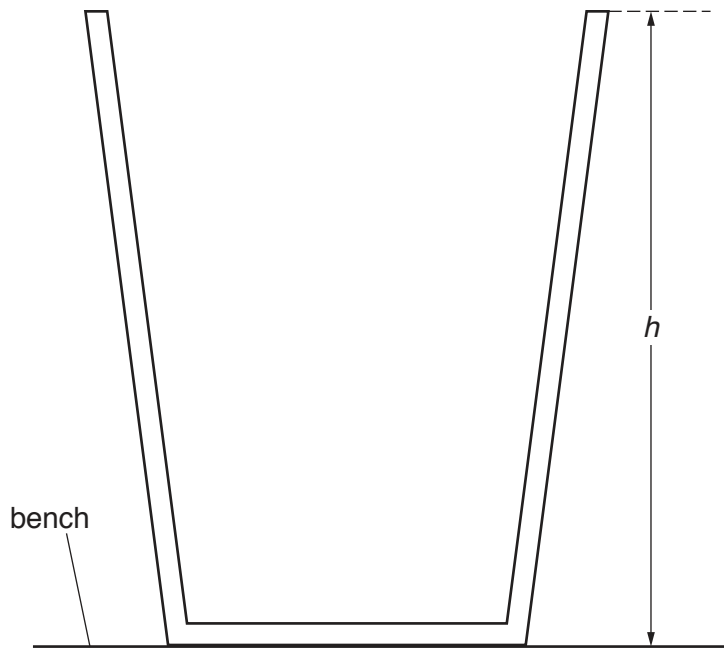

Fig. 5.3

$h = \dots\dots\dots$  cm [1]

(c) (i) Use your measurements from (a)(i) and (a)(ii) to calculate the average diameter  $d_{AV}$  of the cup. Use the equation shown.

$$d_{AV} = \frac{(D + d)}{2}$$

$d_{AV} = \dots\dots\dots$  cm [1]

(ii) Use your values from (b) and (c)(i) to calculate the volume  $V$  of the cup. Use the equation shown.

Give your answer to 3 significant figures.

$$V = 0.785 \times d_{AV}^2 \times h$$

$V = \dots\dots\dots$  cm<sup>3</sup> [2]

(d) Method 2

- She fills a measuring cylinder with water up to the 230 cm<sup>3</sup> mark.
- She pours water from the measuring cylinder into the cup until the cup is full.
- She records the new volume  $V_R$  of water remaining in the measuring cylinder.

Fig. 5.4 shows the reading  $V_R$ .

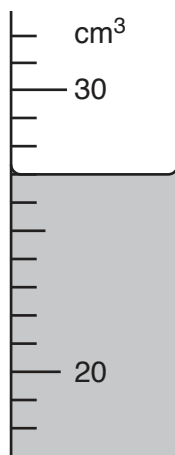

Fig. 5.4

- (i) Calculate the volume of water  $V_W$  that the cup can hold. Use the equation shown.

$$V_W = 230 - V_R$$

$$V_W = \dots\dots\dots \text{cm}^3 \quad [1]$$

- (ii) Describe how the student reads the scale of the measuring cylinder to ensure that her values for volume are as accurate as possible.

.....  
 ..... [1]

- (e) (i) In the equation in (c)(ii),  $h$  should be the inside height of the cup. Explain why your measurement of  $h$  in Fig. 5.3 is likely to be inaccurate.

.....  
 ..... [1]

- (ii) Suggest one practical difficulty the student has in determining an accurate volume  $V_W$  of water that the cup can hold in **method 2**.

.....  
 ..... [1]

[Total: 10]

- 6 A student measures the focal length of a convex lens.

She sets up the apparatus as shown in Fig. 6.1.

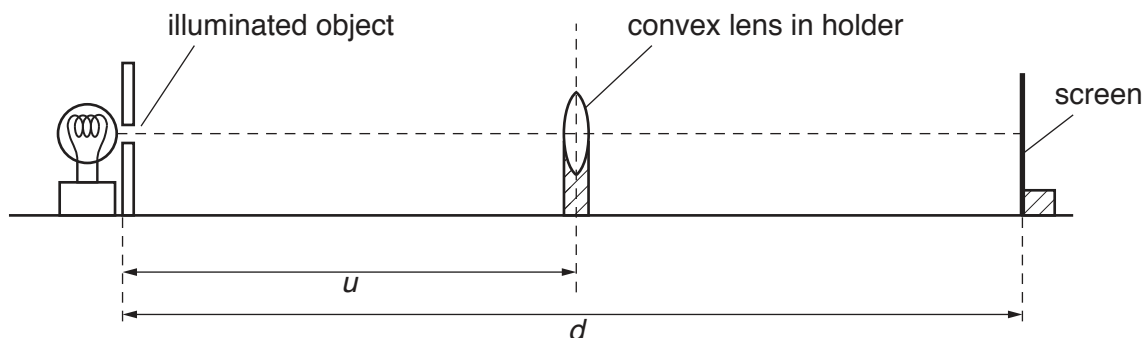

Fig. 6.1

(a) Procedure

- She switches on the lamp and places the lens a distance  $u = 30.0$  cm from the illuminated object. This is the object distance.
  - She adjusts the position of the screen by moving it backwards and forwards along the bench until a sharp image of the illuminated object is formed on the screen.
- (i) Measure on Fig. 6.1 and record to the nearest 0.1 cm the distance  $d$  from the illuminated object to the screen.

$d = \dots\dots\dots$  cm [1]

- (ii) Fig. 6.1 is drawn to a scale of one-fifth full size.

Calculate the actual distance  $d_A$  from the illuminated object to the screen.

$d_A = \dots\dots\dots$  cm [1]

- (iii) Calculate the focal length  $f_A$  of the lens. Use the equation shown.

$$f_A = \frac{30.0 \times (d_A - 30.0)}{d_A}$$

$f_A = \dots\dots\dots$  cm [1]

- (b) She repeats the procedure in (a) but places the lens a distance  $u = 40.0$  cm from the illuminated object.

She measures the distance  $d_B$  from the illuminated object to the screen.

$$d_B = \dots\dots\dots 64.2 \dots\dots\dots \text{ cm}$$

Calculate the focal length  $f_B$  of the lens. Use the equation shown.

$$f_B = \frac{40.0 \times (d_B - 40.0)}{d_B}$$

$$f_B = \dots\dots\dots \text{ cm [1]}$$

- (c) Use your results from (a)(iii) and (b) to calculate an average value for the focal length  $f$  of the lens.

Give your answer to an appropriate number of significant figures. Use the equation shown.

$$f = \frac{(f_A + f_B)}{2}$$

$$f = \dots\dots\dots \text{ cm [2]}$$

- (d) State **one** precaution the student takes to obtain accurate results in this experiment.

.....  
 ..... [1]

- (e) The student wishes to obtain more results to plot a graph to determine the focal length  $f$  of the lens.

Suggest additional values of  $u$  that the student could use.

..... [2]

- (f) On Fig. 6.1 draw a line to show the image distance. Label this line  $v$ . [1]

[Total: 10]

Permission to reproduce items where third-party owned material protected by copyright is included has been sought and cleared where possible. Every reasonable effort has been made by the publisher (UCLES) to trace copyright holders, but if any items requiring clearance have unwittingly been included, the publisher will be pleased to make amends at the earliest possible opportunity.

To avoid the issue of disclosure of answer-related information to candidates, all copyright acknowledgements are reproduced online in the Cambridge Assessment International Education Copyright Acknowledgements Booklet. This is produced for each series of examinations and is freely available to download at [www.cambridgeinternational.org](http://www.cambridgeinternational.org) after the live examination series.

Cambridge Assessment International Education is part of the Cambridge Assessment Group. Cambridge Assessment is the brand name of the University of Cambridge Local Examinations Syndicate (UCLES), which itself is a department of the University of Cambridge.